

LM3502 Step-Up Converter for White LED Applications

 Check for Samples: [LM3502](#)

FEATURES

- Drive up to 4, 6, 8 or 10 White LEDs for Dual Display Backlighting
- >80% Efficiency
- Output Voltage Options: 16V , 25V , 35V, and 44V
- Input Under-Voltage Protection
- Internal Soft Start Eliminating Inrush Current
- 1 MHz Constant Switching Frequency

- **Wide Input Voltage: 2.5V to 5.5V**
- **Small External Components**
- **Low Profile Packages: <1 mm Height**
 - 10 Bump DSBGA
 - 16 Pin WQFN

APPLICATIONS

- Dual Display Backlighting in Portable Devices
- Cellular Phones and PDAs

DESCRIPTION

The LM3502 is a white LED driver for lighting applications. For dual display or large single white LED string backlighting applications, the LM3502 provides a complete solution. The LM3502 contains two internal white LED current bypass FET(Field Effect Transistor) switches that are ideal for controlling dual display applications. The white LED current can be adjusted with a PWM signal directly from a microcontroller without the need of an RC filter network.

With no external compensation, cycle-by-cycle current limit, over-voltage protection, and under-voltage protection, the LM3502 offers superior performance over other application specific standard product step-up white LED drivers.

Typical Application

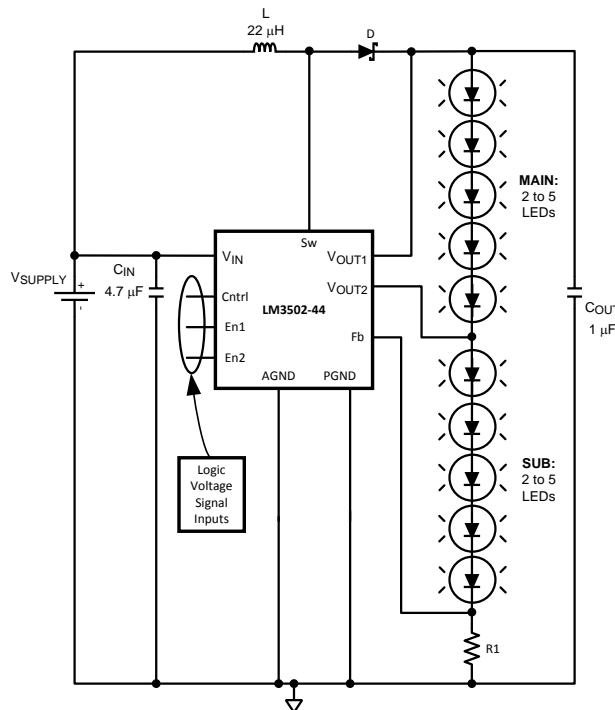

Figure 1. Backlight Configuration with 10 White LEDs



Please be aware that an important notice concerning availability, standard warranty, and use in critical applications of Texas Instruments semiconductor products and disclaimers thereto appears at the end of this data sheet.

All trademarks are the property of their respective owners.

Connection Diagrams

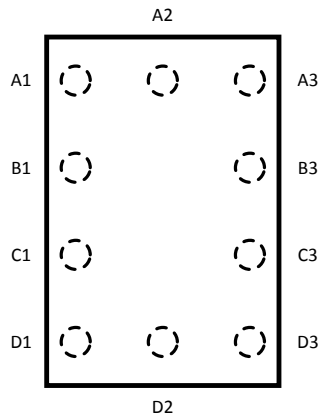

Figure 2. TOP VIEW
10-Bump Thin DSBGA
 See Package Number (YPA0010)

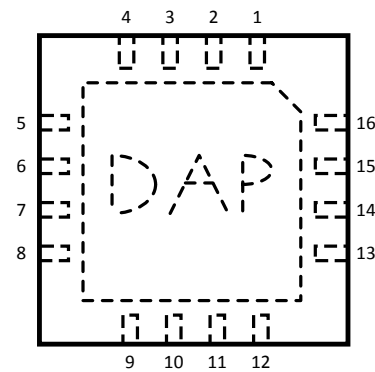

Figure 3. TOP VIEW
16-Lead Thin WQFN
 See Package Number (RGH0016A)

PIN DESCRIPTIONS

Bump #	Pin #	Name	Description
A1	9	Cntrl	Shutdown Control Connection
B1	7	Fb	Feedback Voltage Connection
C1	6	V _{OUT2}	Drain Connections of The NMOS and PMOS Field Effect Transistor (FET) Switches (Figure 4: N2 and P1)
D1	4	V _{OUT1}	Over-Voltage Protection (OVP) and Source Connection of The PMOS FET Switch (Figure 4: P1)
D2	2 and 3	Sw	Drain Connection of The Power NMOS Switch (Figure 4: N1)
D3	15 and 16	PGND	Power Ground Connection
C3	14	AGND	Analog Ground Connection
B3	13	V _{IN}	Supply or Input Voltage Connection
A3	12	En2	NMOS FET Switch Control Connection
A2	10	En1	PMOS FET Switch Control Connection
	1	NC	No Connection
	5	NC	No Connection
	8	NC	No Connection
	11	NC	No Connection
	DAP	DAP	Die Attach Pad (DAP), must be soldered to the printed circuit board's ground plane for enhanced thermal dissipation.

Cntrl (Bump A1): Shutdown control pin

When V_{Cntrl} is $\geq 1.4V$, the LM3502 is enabled or ON. When V_{Cntrl} is $\leq 0.3V$, the LM3502 will enter into shutdown mode operation. The LM3502 has an internal pull down resistor on the Cntrl pin, thus the device is normally in the off state or shutdown mode of operation.

Fb (Bump B1): Output voltage feedback connection

The white LED string network current is set/programmed using a resistor from this pin to ground.

V_{OUT2} (Bump C1): Drain connections of the internal PMOS and NMOS FET switches

(Figure 4: P1 and N2). It is recommended to connect 100nF at V_{OUT2} for the LM3502-35V and LM3502-44 versions if V_{OUT2} is not used.

V_{OUT1} (Bump D1): Source connection of the internal PMOS FET switch (Figure 4: P1) and OVP sensing node

The output capacitor must be connected as close to the device as possible, between the V_{OUT1} pin and ground plane. Also connect the Schottky diode as close as possible to the

V_{OUT1} pin to minimize trace resistance and EMI radiation.

Sw (Bump D2): Drain connection of the internal power NMOS FET switch ([Figure 4: N1](#))

Minimize the metal trace length and maximize the metal trace width connected to this pin to reduce EMI radiation and trace resistance.

PGND (Bump D3): Power ground pin

Connect directly to the ground plane.

AGND (Bump C3): Analog ground pin

Connect the analog ground pin directly to the PGND pin.

V_{IN} (Bump B3): Supply or input voltage connection pin

The C_{IN} capacitor should be as close to the device as possible, between the V_{IN} pin and ground plane.

En2 (Bump A3): Enable pin for the internal NMOS FET switch ([Figure 4: N2](#)) during device operation

When V_{En2} is $\leq 0.3V$, the internal NMOS FET switch turns on and the SUB display turns off. When V_{En2} is $\geq 1.4V$, the internal NMOS FET switch turns off and the SUB display turns on. The En2 pin has an internal pull down resistor, thus the internal NMOS FET switch is normally in the on state of operation with the SUB display turned off.

If V_{En1} and V_{En2} are $\leq 0.3V$ and V_{Cntrl} is $\geq 1.4V$, the LM3502 will enter a low I_Q shutdown mode of operation where all the internal FET switches are off. If V_{OUT2} is not used, En2 must be grounded or floating and use En1 along with Cntrl, to enable the device.

En1 (Bump A2): Enable pin for the internal PMOS FET switch ([Figure 4: P1](#)) during device operation

When V_{En1} is $\leq 0.3V$, the internal PMOS FET switch turns on and the MAIN display is turned off. When V_{En1} is $\geq 1.4V$, the internal PMOS FET switch turns off and the MAIN display is turned on. The En1 pin has an internal pull down resistor, thus the internal PMOS FET switch is normally in the on state of operation with the MAIN display turned off. If V_{En1} and V_{En2} are $\leq 0.3V$ and V_{Cntrl} is $\geq 1.4V$, the LM3502 will enter a low I_Q shutdown mode of operation where all the internal FET switches are off. If V_{OUT2} is not used, En2 must be grounded and use En1 a long with Cntrl, to enable the device.



These devices have limited built-in ESD protection. The leads should be shorted together or the device placed in conductive foam during storage or handling to prevent electrostatic damage to the MOS gates.

Absolute Maximum Ratings ⁽¹⁾⁽²⁾⁽³⁾

V _{IN} Pin	-0.3V to +5.5V
Sw Pin	-0.3V to +48V
Fb Pin	-0.3V to +5.5V
Cntrl Pin	-0.3V to +5.5V
V _{OUT1} Pin	-0.3V to +48V
V _{OUT2} Pin	-0.3V to V _{OUT1}
En1	-0.3V to +5.5V
En2	-0.3V to +5.5V
Continuous Power Dissipation	Internally Limited
Maximum Junction Temperature (T _{J-MAX})	+150°C
Storage Temperature Range	-65°C to +150°C
ESD Rating ⁽⁴⁾	
Human Body Model:	2 kV
Machine Model:	200V

- (1) All voltages are with respect to the potential at the GND pin.
- (2) Absolute maximum ratings indicate limits beyond which damage to the device may occur. Electrical characteristic specifications do not apply when operating the device outside of its rated operating conditions.
- (3) If Military/Aerospace specified devices are required, please contact the Texas Instruments Sales Office/ Distributors for availability and specifications.
- (4) The human body model is a 100 pF capacitor discharged through a 1.5 kΩ resistor into each pin. The machine model is a 200 pF capacitor discharged directly into each pin.

Operating Conditions ⁽¹⁾⁽²⁾

Junction Temperature (T _J) Range	-40°C to +125°C
Ambient Temperature (T _A) Range	-40°C to +85°C
Input Voltage, V _{IN} Pin	2.5V to 5.5V
Cntrl, En1, and En2 Pins	0V to 5.5V

- (1) Absolute maximum ratings indicate limits beyond which damage to the device may occur. Electrical characteristic specifications do not apply when operating the device outside of its rated operating conditions.
- (2) All voltages are with respect to the potential at the GND pin.

Thermal Properties ⁽¹⁾

Junction-to-Ambient Thermal Resistance (θ _{JA})	
DSBGA Package	65°C/W
WQFN Package	49°C/W

- (1) The maximum allowable power dissipation is a function of the maximum junction temperature, T_{J(MAX)}, the junction-to-ambient thermal resistance, θ_{JA}, and the ambient temperature, T_A. See Thermal Properties for the thermal resistance. The maximum allowable power dissipation at any ambient temperature is calculated using: P_{D(MAX)} = (T_{J(MAX)} - T_A)/θ_{JA}. Exceeding the maximum allowable power dissipation will cause excessive die temperature. For more information on this topic, please refer to Application Note 1187: Leadless Leadframe Package (LLP) and Application Note 1112 (AN1112) for DSBGA chip scale package.

Preliminary Electrical Characteristics ^{(1) (2)}

Limits in standard typeface are for T_J = 25°C. Limits in **bold typeface** apply over the full operating junction temperature range (-40°C ≤ T_J ≤ +125°C). Unless otherwise specified, V_{IN} = 2.5V.

Symbol	Parameter	Conditions	Min	Typ	Max	Units
V _{IN}	Input Voltage		2.5		5.5	V
I _Q	Non-Switching	Fb > 0.25V		0.5	1	mA
	Switching	Fb = 0V, Sw Is Floating		1.9	3	mA
	Shutdown	Cntrl = 0V		0.1	3	μA
	Low I _Q Shutdown	Cntrl = 1.5V, En1 = En2 = 0V		6	15	μA
V _{Fb}	Feedback Voltage		0.18	0.25	0.3	V

- (1) All voltages are with respect to the potential at the GND pin.
- (2) Min and Max limits are guaranteed by design, test, or statistical analysis. Typical numbers are not guaranteed, but do represent the most likely norm.

Preliminary Electrical Characteristics ^{(1) (2)} (continued)

 Limits in standard typeface are for $T_J = 25^\circ\text{C}$. Limits in **bold typeface** apply over the full operating junction temperature range ($-40^\circ\text{C} \leq T_J \leq +125^\circ\text{C}$). Unless otherwise specified, $V_{IN} = 2.5\text{V}$.

Symbol	Parameter	Conditions	Min	Typ	Max	Units
I_{CL}	NMOS Power Switch Current Limit	-16, Fb = 0V -25, Fb = 0V -35, Fb = 0V -44, Fb = 0V	250 400 450 450	400 600 750 750	650 800 1050 1050	mA
I_{Fb}	Feedback Pin Bias Current ⁽³⁾	Fb = 0.25V		64	500	nA
F_S	Switching Frequency		0.8	1	1.2	MHz
$R_{DS(ON)}$	NMOS Power Switch ON Resistance (Figure 4: N1)	$I_{Sw} = 500\text{ mA}$		0.55	1.1	Ω
$R_{PDS(ON)}$	PMOS ON Resistance of V_{OUT1}/V_{OUT2} Switch (Figure 4: N1)	$I_{PMOS} = 20\text{ mA}$, En1 = 0V, En2 = 1.5V		5	10	Ω
$R_{NDS(ON)}$	NMOS ON Resistance of V_{OUT2}/Fb Switch (Figure 4: N2)	$I_{NMOS} = 20\text{ mA}$, En1 = 1.5V, En2 = 0V		2.5	5	Ω
D_{MAX}	Maximum Duty Cycle	Fb = 0V	90	95		%
I_{Cntrl}	Cntrl Pin Input Bias Current ⁽⁴⁾	Cntrl = 2.5V Cntrl = 0V		7 0.1	14	μA
I_{Sw}	Sw Pin Leakage Current ⁽⁵⁾	Sw = 42V, Cntrl = 0V		0.01	5	μA
$I_{V_{OUT1}(OFF)}$	V_{OUT1} Pin Leakage Current ⁽⁵⁾	$V_{OUT1} = 14\text{V}$, Cntrl = 0V (16) $V_{OUT1} = 23\text{V}$, Cntrl = 0V (25) $V_{OUT1} = 32\text{V}$, Cntrl = 0V (35) $V_{OUT1} = 42\text{V}$, Cntrl = 0V (44)		0.1 0.1 0.1 0.1	3 3 3 3	μA
$I_{V_{OUT1}(ON)}$	V_{OUT1} Pin Bias Current ⁽⁵⁾	$V_{OUT1} = 14\text{V}$, Cntrl = 1.5V (16) $V_{OUT1} = 23\text{V}$, Cntrl = 1.5V (25) $V_{OUT1} = 32\text{V}$, Cntrl = 1.5V (35) $V_{OUT1} = 42\text{V}$, Cntrl = 1.5V (44)		40 50 50 85	80 100 100 140	μA
$I_{V_{OUT2}}$	V_{OUT2} Pin Leakage Current ⁽⁵⁾	Fb = 0V, Cntrl = 0V, $V_{OUT2} = 42\text{V}$		0.1	3	μA
UVP	Under-Voltage Protection	On Threshold Off Threshold	2.2	2.4 2.3	2.5	V
OVP	Over-Voltage Protection ⁽⁶⁾	On Threshold (16) Off Threshold (16) On Threshold (25) Off Threshold (25) On Threshold (35) Off Threshold (35) On Threshold (44) Off Threshold (44)	14.5 14.0 22.5 21.5 32.0 31.0 40.5 39.0	15.5 15 24 23 34 33 42 41	16.5 16.0 25.5 24.5 35.0 34.0 43.5 42.0	V
V_{En1}	PMOS FET Switch Enabling Threshold (Figure 4: P1)	Off Threshold (Display Lighting) On Threshold (Display Lighting)	1.4	0.8 0.8	0.3	V
V_{En2}	NMOS FET Switch Enabling Threshold (Figure 4: N2)	Off Threshold (Display Lighting) On Threshold (Display Lighting)	1.4	0.8 0.8	0.3	V
V_{Cntrl}	Device Enabling Threshold	Off Threshold OnThreshold	1.4	0.8 0.8	0.3	V
T_{SHDW}	Shutdown Delay Time		8	12	16	ms
I_{En1}	En1 Pin Input Bias Current	En1 = 2.5V En1 = 0V		7 0.1	14	μA

(3) Current flows out of the pin.

(4) Current flows into the pin.

(5) Current flows into the pin.

(6) The on threshold indicates that the LM3502 is no longer switching or regulating LED current, while the off threshold indicates normal operation.

Preliminary Electrical Characteristics ⁽¹⁾ ⁽²⁾ (continued)

Limits in standard typeface are for $T_J = 25^\circ\text{C}$. Limits in **bold typeface** apply over the full operating junction temperature range ($-40^\circ\text{C} \leq T_J \leq +125^\circ\text{C}$). Unless otherwise specified, $V_{IN} = 2.5\text{V}$.

Symbol	Parameter	Conditions	Min	Typ	Max	Units
I_{En2}	En2 Pin Input Bias Current	En2 = 2.5V En2 = 0V		7 0.1	14	μA

BLOCK DIAGRAM

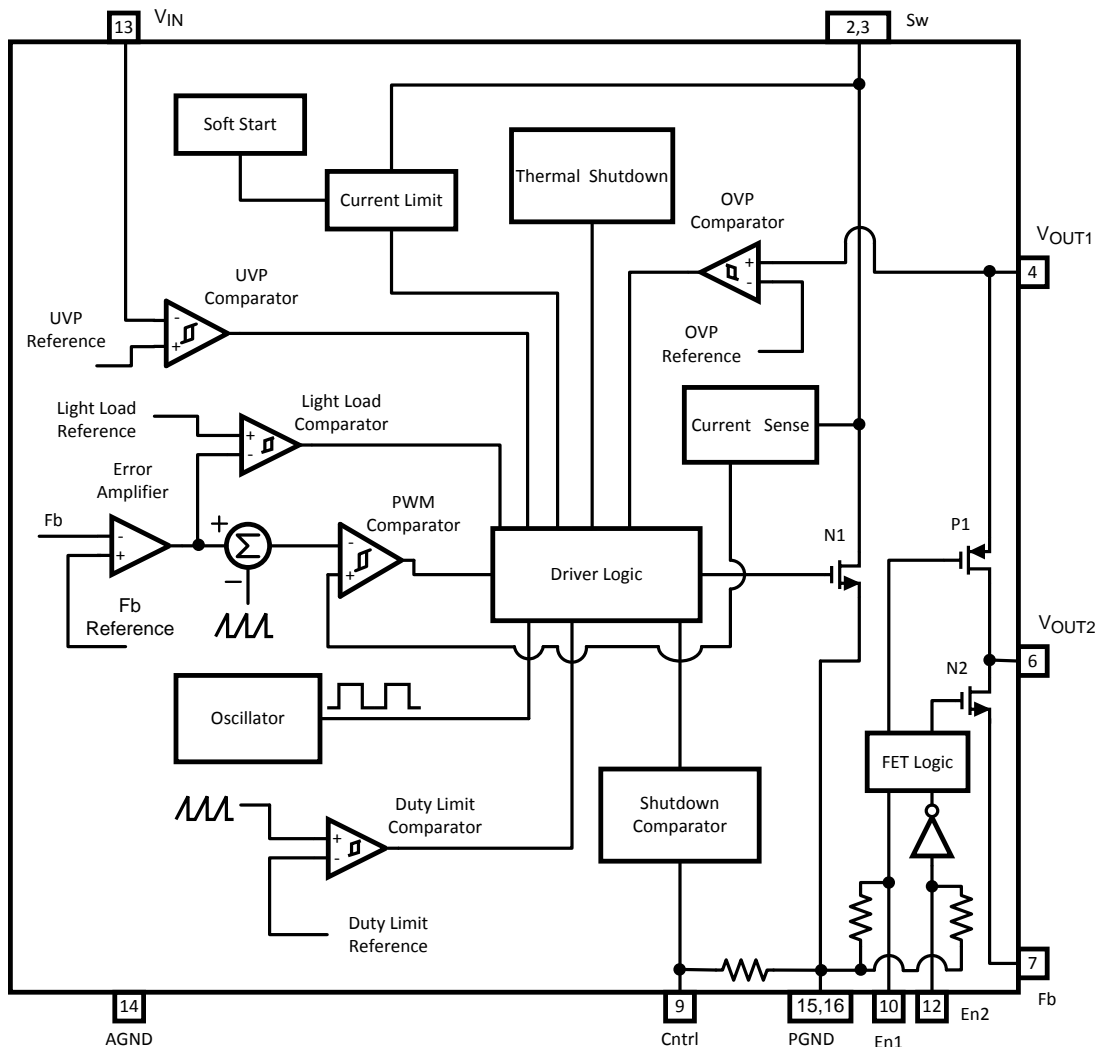

Figure 4. Block Diagram

Detailed Description of Operation

The LM3502 utilizes an asynchronous current mode pulse-width-modulation (PWM) control scheme to regulate the feedback voltage over specified load conditions. The DC/DC converter behaves as a controlled current source for white LED applications. The operation can best be understood by referring to the block diagram in [Figure 4](#) for the following operational explanation. At the start of each cycle, the oscillator sets the driver logic and turns on the internal NMOS power device, N1, conducting current through the inductor and reverse biasing the external diode. The white LED current is supplied by the output capacitor when the internal NMOS power device, N1, is turned on. The sum of the error amplifier's output voltage and an internal voltage ramp are compared with the sensed power NMOS, N1, switch voltage. Once these voltages are equal, the PWM

comparator will then reset the driver logic, thus turning off the internal NMOS power device, N1, and forward biasing the external diode. The inductor current then flows through the diode to the white LED load and output capacitor. The inductor current recharges the output capacitor and supplies the current for the white LED load. The oscillator then resets the driver logic again repeating the process. The output voltage of the error amplifier controls the current through the inductor. This voltage will increase for larger loads and decrease for smaller loads limiting the peak current in the inductor and minimizing EMI radiation. The duty limit comparator is always operational, it prevents the internal NMOS power switch, N1, from being on for more than one oscillator cycle and conducting large amounts of current. The light load comparator allows the LM3502 to properly regulate light/small white LED load currents, where regulation becomes difficult for the LM3502's primary control loop. Under light load conditions, the LM3502 will enter into a pulse skipping pulse-frequency-mode (PFM) of operation where the switching frequency will vary with the load.

The LM3502 has 2 control pins, En1 and En2, used for selecting which segment of a single white LED string network is active for dual display applications. En1 controls the main display (MAIN) segment of the single string white LED network between pins V_{OUT1} and V_{OUT2} . En2 controls the sub display (SUB) segment of the single string white LED network between the V_{OUT2} and Fb. For a quick review of the LM3502 control pin operational characteristics, see [Figure 5](#).

When the Cntrl pin is $\geq 1.4V$, the LM3502 will enter in low I_Q state if both En1 and En2 $\leq 0.3V$. At this time, both the P1 and N2 FETs will turn off. The output voltage will be a diode drop below the supply voltage and the soft-start will be reset limiting the peak inductor current at the next start-up.

The LM3502 is designed to control the LED current with a PWM signal without the use of an external RC filter. Utilizing special circuitry, the LM3502 can operate over a large range of PWM frequencies without restarting the soft-start allowing for fast recovery at high PWM frequencies. [Figure 6](#) represents a PWM signal driving the Cntrl pin where t_L is defined as the low time of the signal. The following is true:

- If $t_L < 12ms$ (typical): The device will stop switching during this time and the soft-start will not be reset allowing LED current PWM control.
- If $t_L > 12ms$ (typical): The device will shutdown and the soft-start will reset to prevent high peak currents at the next startup. Both the N2 and P1 switches will turn off.

The LM3502 has dedicated protection circuitry active during normal operation to protect the integrated circuit (IC) and external components. The thermal shutdown circuitry turns off the internal NMOS power device, N1, when the internal semiconductor junction temperature reaches excessive levels. The LM3502 has a under-voltage protection (UVP) comparator that disables the internal NMOS power device when battery voltages are too low, thus preventing an on state where the internal NMOS power device conducts large amounts of current. The over-voltage protection (OVP) comparator prevents the output voltage from increasing beyond the protection limit when the white LED string network is removed or if there is a white LED failure. OVP allows for the use of low profile ceramic capacitors at the output. The current through the internal NMOS power device, N1, is monitored to prevent peak inductor currents from damaging the IC. If during a cycle (cycle=1/switching frequency) the peak inductor current exceeds the current limit for the LM3502, the internal NMOS power device will be turned off for the remaining duration of that cycle.

Cntrl*	En1	En2	Result* (See Figure 1 and Figure 2)	Shutdown	
				Shutdown	Low I _Q
1.4V	0.3V	0.3V	[P1→OFF N2→OFF N1→OFF] or [MAIN→OFF SUB→OFF N1→OFF]		X
1.4V	1.4V	0.3V	[P1→OFF N2→ON N1→Switching] or [MAIN→ON SUB→OFF N1→Switching]		
1.4V	0.3V	1.4V	[P1→ON N2→OFF N1→Switching] or [MAIN→OFF SUB→ON N1→Switching]		
1.4V	1.4V	1.4V	[P1→OFF N2→OFF N1→Switching] or [MAIN→ON SUB→ON N1→Switching]		
0.3V	0.3V	0.3V	[P1→OFF N2→OFF N1→OFF] or [MAIN→OFF SUB→OFF N1→OFF]	X	
0.3V	1.4V	0.3V	[P1→OFF N2→OFF N1→OFF] or [MAIN→OFF SUB→OFF N1→OFF]	X	
0.3V	0.3V	1.4V	[P1→OFF N2→OFF N1→OFF] or [MAIN→OFF SUB→OFF N1→OFF]	X	
0.3V	1.4V	1.4V	[P1→OFF N2→OFF N1→OFF] or [MAIN→OFF SUB→OFF N1→OFF]	X	

*Table is only valid for when the Cntrl pin signal is a non-periodic logic signal, not a PWM signal.

Figure 5. Operational Characteristics Table

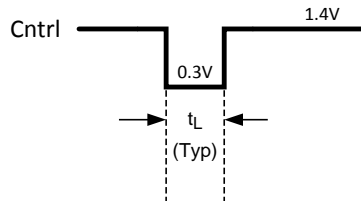

Figure 6. Control Signal Waveform

Typical Performance Characteristics

(Circuit in Figure 1: L = DO1608C-223 and D = MBRM140T3. Efficiency: $\eta = P_{OUT}/P_{IN} = [(V_{OUT} - V_{FB}) * I_{OUT}]/[V_{IN} * I_{IN}]$. $T_A = 25^\circ\text{C}$, unless otherwise stated.)

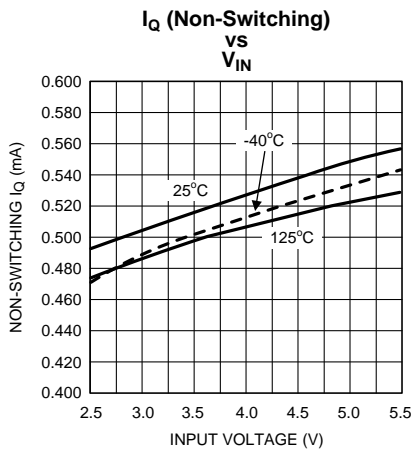

Figure 7.

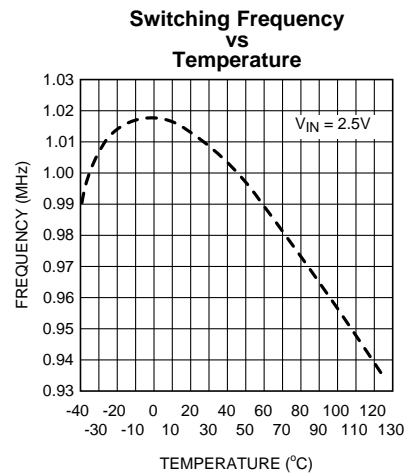

Figure 8.

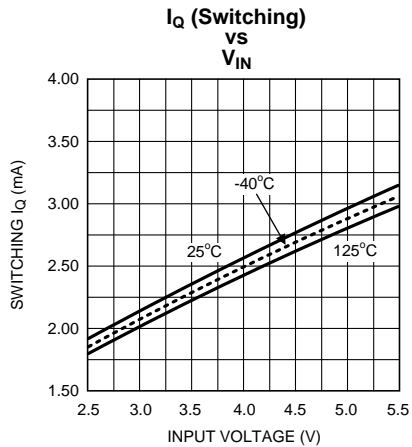

Figure 9.

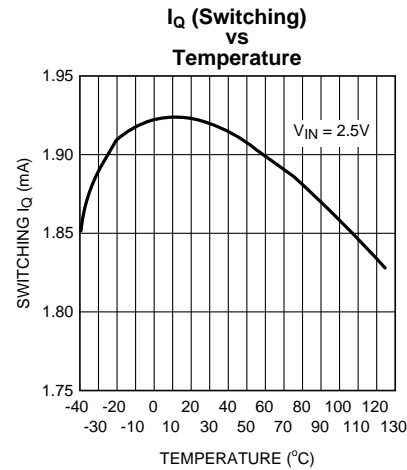

Figure 10.

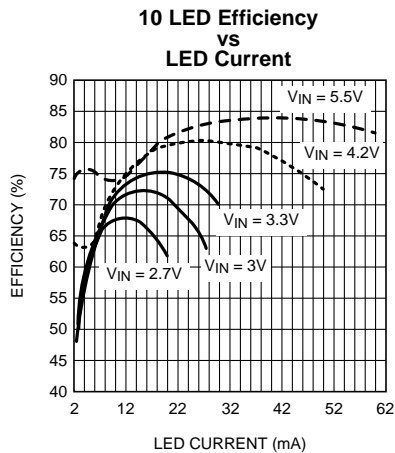

Figure 11.

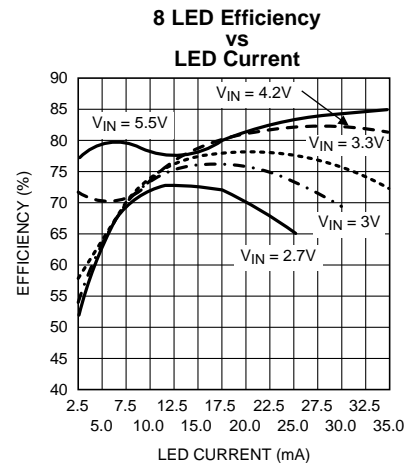

Figure 12.

Typical Performance Characteristics (continued)

(Circuit in [Figure 1](#): L = DO1608C-223 and D = MBRM140T3. Efficiency: $\eta = P_{OUT}/P_{IN} = [(V_{OUT} - V_{FB}) * I_{OUT}]/[V_{IN} * I_{IN}]$. $T_A = 25^\circ\text{C}$, unless otherwise stated.)

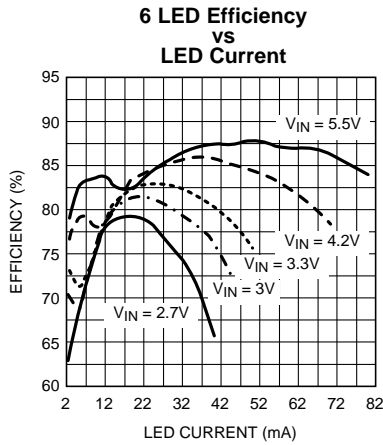

Figure 13.

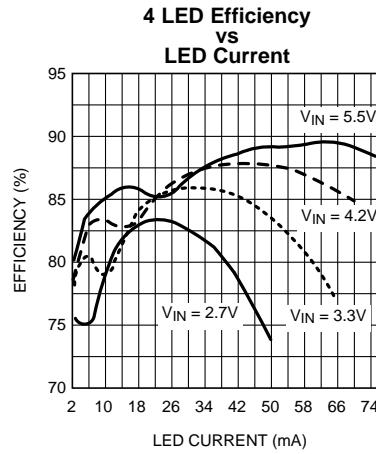

Figure 14.

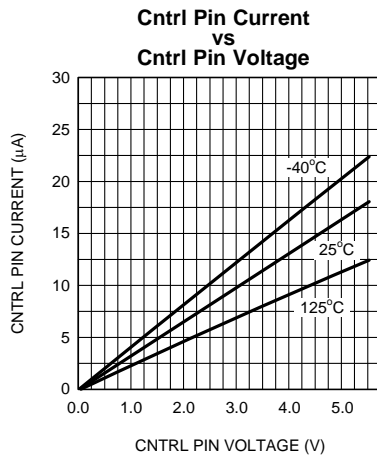

Figure 15.

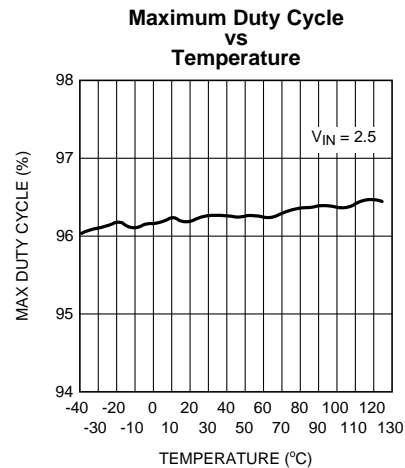

Figure 16.

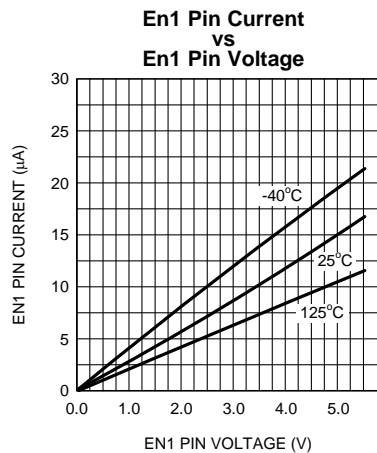

Figure 17.

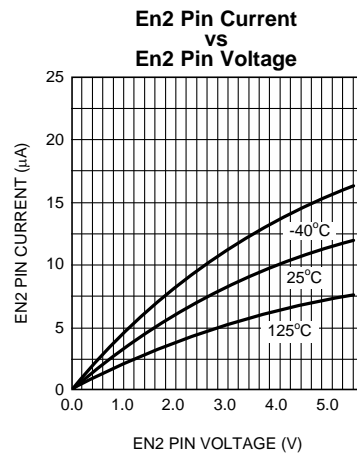

Figure 18.

Typical Performance Characteristics (continued)

(Circuit in Figure 1: L = DO1608C-223 and D = MBRM140T3. Efficiency: $\eta = P_{OUT}/P_{IN} = [(V_{OUT} - V_{FB}) * I_{OUT}]/[V_{IN} * I_{IN}]$. $T_A = 25^\circ\text{C}$, unless otherwise stated.)

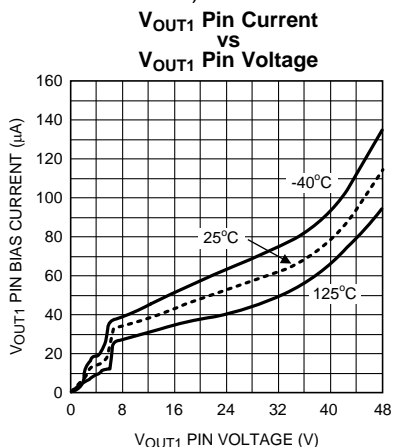

Figure 19.

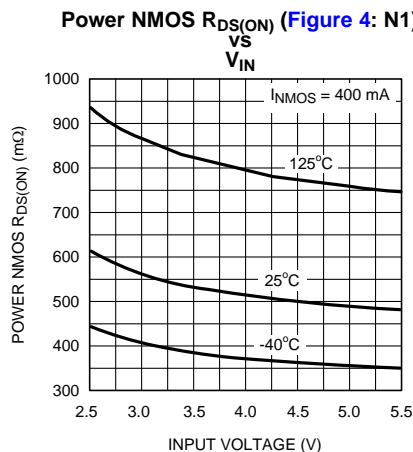

Figure 20.

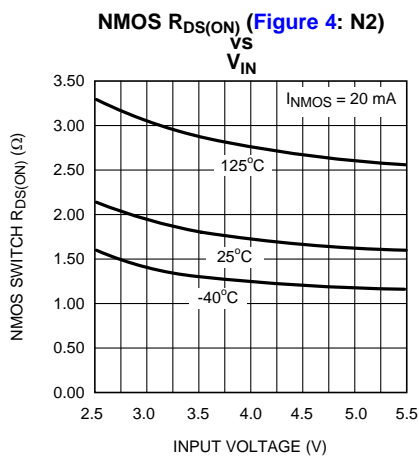

Figure 21.

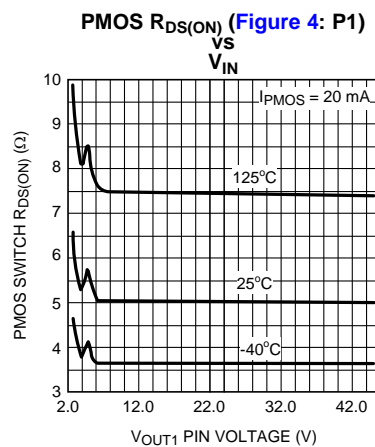

Figure 22.

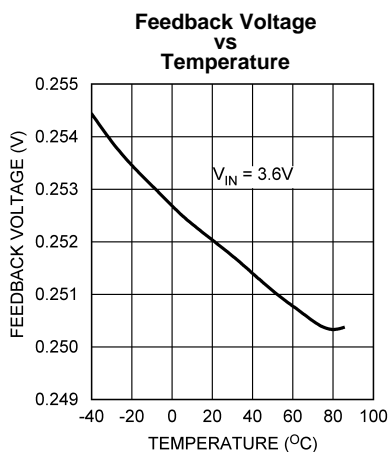

Figure 23.

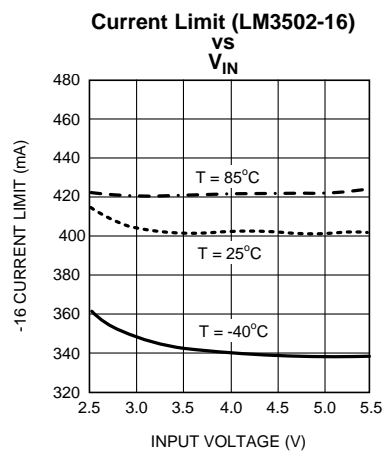

Figure 24.

Typical Performance Characteristics (continued)

(Circuit in [Figure 1](#): L = DO1608C-223 and D = MBRM140T3. Efficiency: $\eta = P_{OUT}/P_{IN} = [(V_{OUT} - V_{FB}) * I_{OUT}]/[V_{IN} * I_{IN}]$. $T_A = 25^\circ\text{C}$, unless otherwise stated.)

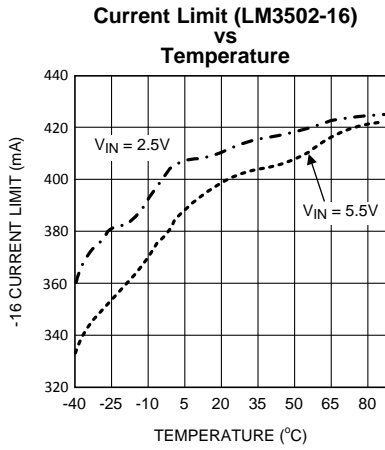

Figure 25.

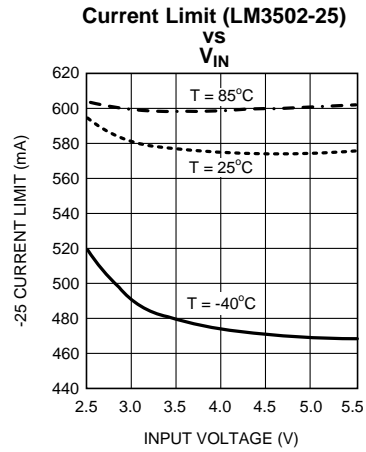

Figure 26.

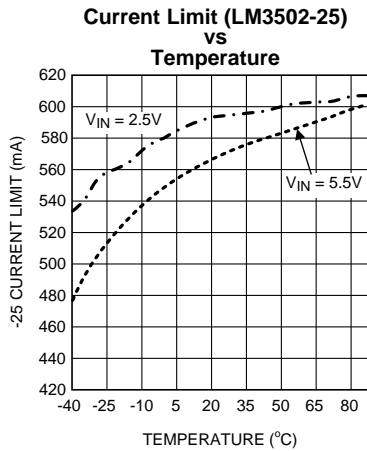

Figure 27.

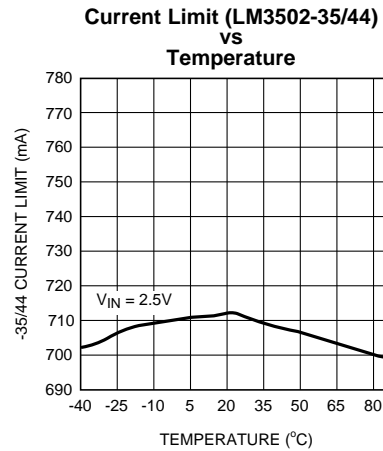

Figure 28.

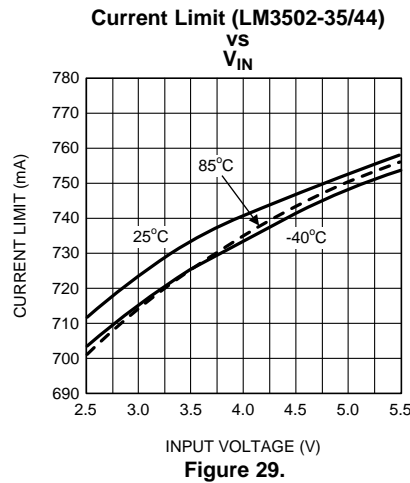

Figure 29.

APPLICATION INFORMATION

WHITE LED CURRENT SETTING

The LED current is set using the following equation:

$$I_{LED} = \frac{V_{Fb}}{R1}$$

where

- I_{LED} : White LED Current.
- V_{Fb} : Feedback Pin Voltage. $V_{Fb} = 0.25V$, Typical.
- $R1$: Current Setting Resistor.

(1)

WHITE LED DIMMING

For dimming the white LED string with a pulse-width-modulated (PWM) signal on the Cntrl pin, care must be taken to balance the tradeoffs between audible noise and white LED brightness control. For best PWM duty cycle vs. white LED current linearity, the PWM frequency should be between 200Hz and 500Hz. Other PWM frequencies can be used, but the linearity over input voltage and duty cycle variation will not be as good as what the 200Hz to 500Hz PWM frequency spectrum provides. To minimize audible noise interference, it is recommended that an output capacitor with minimal susceptibility to piezoelectric induced stresses be used for the particular applications that require minimal or no audible noise interference.

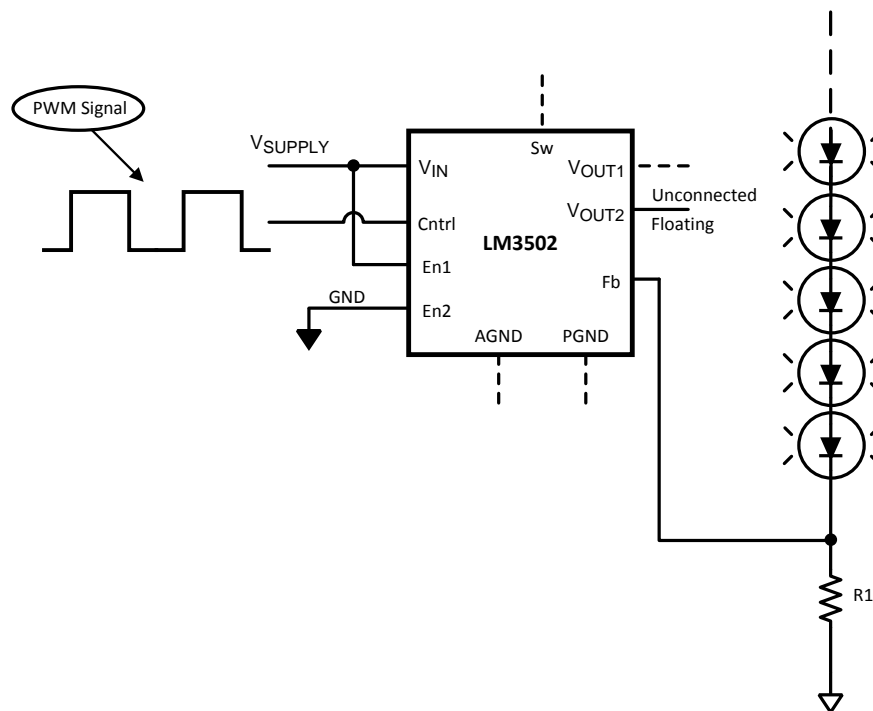

If V_{OUT2} is not used, En2 must be grounded

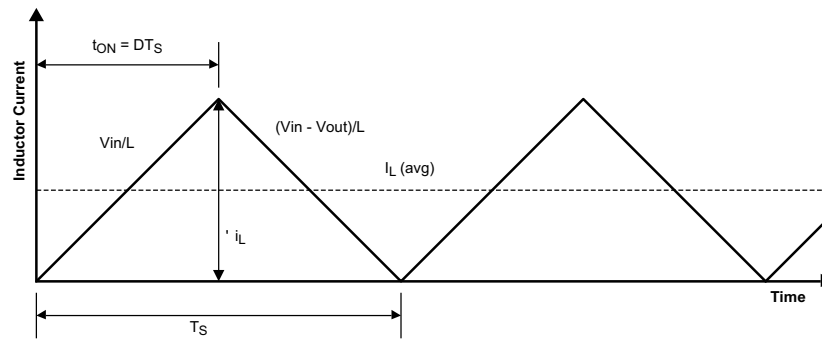

Figure 30. Inductor Current Waveform

CONTINUOUS AND DISCONTINUOUS MODES OF OPERATION

Since the LM3502 is a constant frequency pulse-width-modulated step-up regulator, care must be taken to make sure the maximum duty cycle specification is not violated. The duty cycle equation depends on which mode of operation the LM3502 is in. The two operational modes of the LM3502 are continuous conduction mode (CCM) and discontinuous conduction mode (DCM). Continuous conduction mode refers to the mode of operation where during the switching cycle, the inductor current never goes to and stays at zero for any significant amount of time during the switching cycle. Discontinuous conduction mode refers to the mode of operation where during the switching cycle, the inductor current goes to and stays at zero for a significant amount of time during the switching cycle. Figure 30 illustrates the threshold between CCM and DCM operation. In Figure 30, the inductor current is right on the CCM/DCM operational threshold. Using this as a reference, a factor can be introduced to calculate when a particular application is in CCM or DCM operation. R is a CCM/DCM factor we can use to compute which mode of operation a particular application is in. If R is ≥ 1 , then the application is operating in CCM. Conversely, if R is < 1 , the application is operating in DCM. The R factor inequalities are a result of the components that make up the R factor. From Figure 30, the R factor is equal to the average inductor current, $I_L(\text{avg})$, divided by half the inductor ripple current, Δi_L . Using Figure 30 the following equation can be used to compute R factor:

$$R = \frac{2 * I_L(\text{avg})}{\Delta i_L}$$

$$I_L(\text{avg}) = \frac{[I_{\text{OUT}}]}{[(1-D) * \text{Eff}]}$$

$$\Delta i_L = \frac{[V_{\text{IN}} * D]}{[L * F_s]}$$

$$R = \frac{[2 * I_{\text{OUT}} * L * F_s * (V_{\text{OUT}})^2]}{[(V_{\text{IN}})^2 * \text{Eff} * (V_{\text{OUT}} - V_{\text{IN}})]}$$

where

- V_{IN} : Input Voltage.
- V_{OUT} : Output Voltage.
- Eff: Efficiency of the LM3502.
- F_s : Switching Frequency.
- I_{OUT} : White LED Current/Load Current.
- L: Inductance Magnitude/Inductor Value.
- D: Duty Cycle for CCM Operation.
- Δi_L : Inductor Ripple Current
- $I_L(\text{avg})$: Average Inductor Current

(2)

For CCM operation, the duty cycle can be computed with:

$$D = \frac{t_{ON}}{T_S}$$

$$D = \frac{[V_{OUT} - V_{IN}]}{[V_{OUT}]}$$

where

- D: Duty Cycle for CCM Operation.
- V_{OUT} : Output Voltage.
- V_{IN} : Input Voltage.

(3)

For DCM operation, the duty cycle can be computed with:

$$D = \frac{t_{ON}}{T_S}$$

$$D = \sqrt{\frac{[2 * I_{OUT} * L * (V_{OUT} - V_{IN}) * F_s]}{[(V_{IN})^2 * Eff]}}$$

where

- D: Duty Cycle for DCM Operation.
- V_{OUT} : Output Voltage.
- V_{IN} : Input Voltage.
- I_{OUT} : White LED Current/Load Current.
- F_s : Switching Frequency.
- L: Inductor Value/Inductance Magnitude.

(4)

INDUCTOR SELECTION

In order to maintain inductance, an inductor used with the LM3502 should have a saturation current rating larger than the peak inductor current of the particular application. Inductors with low DCR values contribute decreased power losses and increased efficiency. The peak inductor current can be computed for both modes of operation: CCM and DCM.

The cycle-by-cycle peak inductor current for CCM operation can be computed with:

$$I_{Peak} \approx I_L (avg) + \frac{\Delta i_L}{2}$$

$$I_{Peak} \approx \frac{[I_{OUT}]}{[(1 - D) * Eff]} + \frac{[V_{IN} * D]}{[2 * L * F_s]}$$

where

- V_{IN} : Input Voltage.
- Eff: Efficiency of the LM3502.
- F_s : Switching Frequency.
- I_{OUT} : White LED Current/Load Current.
- L: Inductance Magnitude/Inductor Value.
- D: Duty Cycle for CCM Operation.
- I_{PEAK} : Peak Inductor Current.
- Δi_L : Inductor Ripple Current.
- $I_L(avg)$: Average Inductor Current.

(5)

The cycle-by-cycle peak inductor current for DCM operation can be computed with:

$$I_{Peak} \approx \frac{[V_{IN} * D]}{[L * F_s]}$$

where

- V_{IN} : Input Voltage.

- F_s : Switching Frequency.
 - L : Inductance Magnitude/Inductor Value.
 - D : Duty Cycle for DCM Operation.
 - I_{PEAK} : Peak Inductor Current.
- (6)

The minimum inductance magnitude/inductor value for the LM3502 can be calculated using the following, which is only valid when the duty cycle is > 0.5 :

$$L > \frac{[V_{IN} * R_{DS(ON)} * ((D/D') - 1)]}{[1.562 * F_s]}$$

where

- D : Duty Cycle.
 - D' : $1-D$.
 - $R_{DS(ON)}$: NMOS Power Switch ON
 - V_{IN} : Input Voltage.
 - L : Inductance Magnitude/Inductor Value.
- (7)

This equation gives the value required to prevent subharmonic oscillations. The result of this equation and the inductor average and ripple current should be accounted for when choosing an inductor value.

Some recommended inductor manufacturers included but are not limited to:

CoilCraft	DO1608C-223	www.coilcraft.com
	DT1608C-223	

CAPACITOR SELECTION

Multilayer ceramic capacitors are the best choice for use with the LM3502. Multilayer ceramic capacitors have the lowest equivalent series resistance (ESR). Applied voltage or DC bias, temperature, dielectric material type (X7R, X5R, Y5V, etc), and manufacturer component tolerance have an affect on the true or effective capacitance of a ceramic capacitor. Be aware of how your application will affect a particular ceramic capacitor by analyzing the aforementioned factors of your application. Before selecting a capacitor always consult the capacitor manufacturer's data curves to verify the effective or true capacitance in your application.

INPUT CAPACITOR SELECTION

The input capacitor serves as an energy reservoir for the inductor. In addition to acting as an energy reservoir for the inductor the input capacitor is necessary for the reduction in input voltage ripple and noise experienced by the LM3502. The reduction in input voltage ripple and noise helps ensure the LM3502's proper operation, and reduces the effect of the LM3502 on other devices sharing the same supply voltage. To ensure low input voltage ripple, the input capacitor must have an extremely low ESR. As a result of the low input voltage ripple requirement multilayer ceramic capacitors are the best choice. A minimum capacitance of 2.0 μF is required for normal operation, so consult the capacitor manufacturer's data curves to verify whether the minimum capacitance requirement is going to be achieved for a particular application.

OUTPUT CAPACITOR SELECTION

The output capacitor serves as an energy reservoir for the white LED load when the internal power FET switch (Figure 4: N1) is on or conducting current. The requirements for the output capacitor must include worst case operation such as when the load opens up and the LM3502 operates in over-voltage protection (OVP) mode operation. A minimum capacitance of 0.5 μF is required to ensure normal operation. Consult the capacitor manufacturer's data curves to verify whether the minimum capacitance requirement is going to be achieved for a particular application.

Some recommended capacitor manufacturers included but are not limited to:

Taiyo Yuden	GMK212BJ105MD (0805/35V)	www.t-yuden.com
muRata	GRM40-035X7R105K (0805/50V)	www.murata.com

TDK	C3216X7R1H105KT (1206/50V)	www.tdktca.com
	C3216X7R1C475K (1206/16V)	
AVX	08053D105MAT (0805/25V)	www.avxcorp.com
	08056D475KAT (0805/6.3V)	
	1206ZD475MAT (1206/10V)	

DIODE SELECTION

To maintain high efficiency it is recommended that the average current rating (I_F or I_O) of the selected diode should be larger than the peak inductor current ($I_{L_{peak}}$). At the minimum, the average current rating of the diode should be larger than the maximum LED current. To maintain diode integrity the peak repetitive forward current (I_{FRM}) must be greater than or equal to the peak inductor current ($I_{L_{peak}}$). Diodes with low forward voltage ratings (V_F) and low junction capacitance magnitudes (C_J or C_T or C_D) are conducive to high efficiency. The chosen diode must have a reverse breakdown voltage rating (V_R and/or V_{RRM}) that is larger than the output voltage (V_{out}). No matter what type of diode is chosen, Schottky or not, certain selection criteria must be followed:

1. V_R and $V_{RRM} > V_{OUT}$
2. I_F or $I_O \geq I_{LOAD}$ or I_{OUT}
3. $I_{FRM} \geq I_{L_{peak}}$

Some recommended diode manufacturers included but are not limited to:

Vishay	SS12(1A/20V)	www.vishay.com
	SS14(1A/40V)	
	SS16(1A/60V)	
On Semiconductor	MBRM120E (1A/20V)	www.onsemi.com
	MBRS1540T3 (1.5A/40V)	
	MBR240LT (2A/40V)	
Central Semiconductor	CMSH1- 40M (1A/40V)	www.centrasemi.com

SHUTDOWN AND START-UP

On startup, the LM3502 contains special circuitry that limits the peak inductor current which prevents large current spikes from loading the battery or power supply. When $Cntrl \geq 1.4V$ and both the En1 and En2 signals are less than 0.3V, the LM3502 will enter a low I_Q state and regulation will end. During this low I_Q mode the output voltage is a diode drop below the supply voltage and the soft-start will be reset to limit the peak inductor current at the next startup. When both En1 and En2 are less than 0.3V, the P1 PMOS and N2 NMOS switches will turn off.

When $Cntrl < 0.3V$ for more than 12ms, typically, the LM3502 will shutdown and the output voltage will be a diode drop below the supply voltage. If the Cntrl pin is low for more than 12ms, the soft-start will reset to limit the peak inductor current at the next startup.

When $Cntrl$ is < 0.3 but for less than 12ms, typically, the device will not shutdown and reset the soft-start but shut off the NMOS N1 Power Device to allow for PWM control of the LED current.

THERMAL SHUTDOWN

The LM3502 stops regulating when the internal semiconductor junction temperature reaches approximately 140°C. The internal thermal shutdown has approximately 20°C of hysteresis which results in the LM3502 turning back on when the internal semiconductor junction temperature reaches 120°C. When the thermal shutdown temperature is reached, the softstart is reset to prevent inrush current when the die temperature cools.

UNDER VOLTAGE PROTECTION

The LM3502 contains protection circuitry to prevent operation for low input supply voltages. When V_{in} drops below 2.3V, typically the LM3502 will no longer regulate. In this mode, the output voltage will be one diode drop below V_{in} and the softstart will be reset. When V_{in} increases above 2.4V, typically, the device will begin regulating again.

OVER VOLTAGE PROTECTION

The LM3502 contains dedicated circuitry for monitoring the output voltage. In the event that the LED network is disconnected from the LM3502, the output voltage will increase and be limited to 15.5V(typ.) for the 16V version, 24V(typ.) for the 25V version, 34V(typ.) for the 35V version and 42V(typ.) for the 44V version (see electrical table for more details). In the event that the network is reconnected, regulation will resume at the appropriate output voltage.

LAYOUT CONSIDERATIONS

All components, except for the white LEDs, must be placed as close as possible to the LM3502. The die attach pad (DAP) must be soldered to the ground plane.

The input bypass capacitor C_{IN} , as shown in [Figure 1](#), must be placed close to the IC and connect between the V_{IN} and PGND pins. This will reduce copper trace resistance which effects input voltage ripple of the IC. For additional input voltage filtering, a 100nF bypass capacitor can be placed in parallel with C_{IN} to shunt any high frequency noise to ground. The output capacitor, C_{OUT} , must be placed close to the IC and be connected between the V_{OUT1} and PGND pins. Any copper trace connections for the C_{OUT} capacitor can increase the series resistance, which directly effects output voltage ripple and efficiency. The current setting resistor, R1, should be kept close to the Fb pin to minimize copper trace connections that can inject noise into the system. The ground connection for the current setting resistor network should connect directly to the PGND pin. The AGND pin should be tied directly to the PGND pin. Trace connections made to the inductor should be minimized to reduce power dissipation and increase overall efficiency while reducing EMI radiation. For more details regarding layout guidelines for switching regulators, refer to Applications Note AN-1149.

PACKAGING INFORMATION

Orderable Device	Status (1)	Package Type	Package Drawing	Pins	Package Qty	Eco Plan (2)	Lead/Ball Finish	MSL Peak Temp (3)	Op Temp (°C)	Top-Side Markings (4)	Samples
LM3502ITL-16/NOPB	ACTIVE	DSBGA	YPA	10	250	Green (RoHS & no Sb/Br)	SNAGCU	Level-1-260C-UNLIM	-40 to 125	SANB	Samples
LM3502ITL-25/NOPB	ACTIVE	DSBGA	YPA	10	250	Green (RoHS & no Sb/Br)	SNAGCU	Level-1-260C-UNLIM	-40 to 125	SAPB	Samples
LM3502ITL-35/NOPB	ACTIVE	DSBGA	YPA	10	250	Green (RoHS & no Sb/Br)	SNAGCU	Level-1-260C-UNLIM	-40 to 125	SARB	Samples
LM3502ITL-44/NOPB	ACTIVE	DSBGA	YPA	10	250	Green (RoHS & no Sb/Br)	SNAGCU	Level-1-260C-UNLIM	-40 to 125	SDLB	Samples
LM3502ITLX-16/NOPB	ACTIVE	DSBGA	YPA	10	3000	Green (RoHS & no Sb/Br)	SNAGCU	Level-1-260C-UNLIM	-40 to 125	SANB	Samples
LM3502ITLX-25/NOPB	ACTIVE	DSBGA	YPA	10	3000	Green (RoHS & no Sb/Br)	SNAGCU	Level-1-260C-UNLIM	-40 to 125	SAPB	Samples
LM3502ITLX-35/NOPB	ACTIVE	DSBGA	YPA	10	3000	Green (RoHS & no Sb/Br)	SNAGCU	Level-1-260C-UNLIM	-40 to 125	SARB	Samples
LM3502ITLX-44/NOPB	ACTIVE	DSBGA	YPA	10	3000	Green (RoHS & no Sb/Br)	SNAGCU	Level-1-260C-UNLIM	-40 to 125	SDLB	Samples
LM3502SQ-16	ACTIVE	WQFN	RGH	16	1000	TBD	Call TI	Call TI	-40 to 125	L00048B	Samples
LM3502SQ-16/NOPB	ACTIVE	WQFN	RGH	16	1000	Green (RoHS & no Sb/Br)	CU SN	Level-1-260C-UNLIM	-40 to 125	L00048B	Samples
LM3502SQ-25	ACTIVE	WQFN	RGH	16	1000	TBD	Call TI	Call TI	-40 to 125	L00049B	Samples
LM3502SQ-25/NOPB	ACTIVE	WQFN	RGH	16	1000	Green (RoHS & no Sb/Br)	CU SN	Level-1-260C-UNLIM	-40 to 125	L00049B	Samples
LM3502SQ-35	ACTIVE	WQFN	RGH	16	1000	TBD	Call TI	Call TI	-40 to 125	L00044B	Samples
LM3502SQ-35/NOPB	ACTIVE	WQFN	RGH	16	1000	Green (RoHS & no Sb/Br)	CU SN	Level-1-260C-UNLIM	-40 to 125	L00044B	Samples
LM3502SQ-44	ACTIVE	WQFN	RGH	16	1000	TBD	Call TI	Call TI	-40 to 125	L00050B	Samples
LM3502SQ-44/NOPB	ACTIVE	WQFN	RGH	16	1000	Green (RoHS & no Sb/Br)	CU SN	Level-1-260C-UNLIM	-40 to 125	L00050B	Samples
LM3502SQX-16	ACTIVE	WQFN	RGH	16	4500	TBD	Call TI	Call TI	-40 to 125	L00048B	Samples
LM3502SQX-16/NOPB	ACTIVE	WQFN	RGH	16	4500	Green (RoHS & no Sb/Br)	CU SN	Level-1-260C-UNLIM	-40 to 125	L00048B	Samples

Orderable Device	Status (1)	Package Type	Package Drawing	Pins	Package Qty	Eco Plan (2)	Lead/Ball Finish	MSL Peak Temp (3)	Op Temp (°C)	Top-Side Markings (4)	Samples
LM3502SQX-25	ACTIVE	WQFN	RGH	16	4500	TBD	Call TI	Call TI	-40 to 125	L00049B	Samples
LM3502SQX-25/NOPB	ACTIVE	WQFN	RGH	16	4500	Green (RoHS & no Sb/Br)	CU SN	Level-1-260C-UNLIM	-40 to 125	L00049B	Samples
LM3502SQX-35	ACTIVE	WQFN	RGH	16	4500	TBD	Call TI	Call TI	-40 to 125	L00044B	Samples
LM3502SQX-35/NOPB	ACTIVE	WQFN	RGH	16	4500	Green (RoHS & no Sb/Br)	CU SN	Level-1-260C-UNLIM	-40 to 125	L00044B	Samples
LM3502SQX-44	ACTIVE	WQFN	RGH	16	4500	TBD	Call TI	Call TI	-40 to 125	L00050B	Samples
LM3502SQX-44/NOPB	ACTIVE	WQFN	RGH	16	4500	Green (RoHS & no Sb/Br)	CU SN	Level-1-260C-UNLIM	-40 to 125	L00050B	Samples

(1) The marketing status values are defined as follows:

ACTIVE: Product device recommended for new designs.

LIFEBUY: TI has announced that the device will be discontinued, and a lifetime-buy period is in effect.

NRND: Not recommended for new designs. Device is in production to support existing customers, but TI does not recommend using this part in a new design.

PREVIEW: Device has been announced but is not in production. Samples may or may not be available.

OBSOLETE: TI has discontinued the production of the device.

(2) Eco Plan - The planned eco-friendly classification: Pb-Free (RoHS), Pb-Free (RoHS Exempt), or Green (RoHS & no Sb/Br) - please check <http://www.ti.com/productcontent> for the latest availability information and additional product content details.

TBD: The Pb-Free/Green conversion plan has not been defined.

Pb-Free (RoHS): TI's terms "Lead-Free" or "Pb-Free" mean semiconductor products that are compatible with the current RoHS requirements for all 6 substances, including the requirement that lead not exceed 0.1% by weight in homogeneous materials. Where designed to be soldered at high temperatures, TI Pb-Free products are suitable for use in specified lead-free processes.

Pb-Free (RoHS Exempt): This component has a RoHS exemption for either 1) lead-based flip-chip solder bumps used between the die and package, or 2) lead-based die adhesive used between the die and leadframe. The component is otherwise considered Pb-Free (RoHS compatible) as defined above.

Green (RoHS & no Sb/Br): TI defines "Green" to mean Pb-Free (RoHS compatible), and free of Bromine (Br) and Antimony (Sb) based flame retardants (Br or Sb do not exceed 0.1% by weight in homogeneous material)

(3) MSL, Peak Temp. -- The Moisture Sensitivity Level rating according to the JEDEC industry standard classifications, and peak solder temperature.

(4) Only one of markings shown within the brackets will appear on the physical device.

Important Information and Disclaimer: The information provided on this page represents TI's knowledge and belief as of the date that it is provided. TI bases its knowledge and belief on information provided by third parties, and makes no representation or warranty as to the accuracy of such information. Efforts are underway to better integrate information from third parties. TI has taken and continues to take reasonable steps to provide representative and accurate information but may not have conducted destructive testing or chemical analysis on incoming materials and chemicals. TI and TI suppliers consider certain information to be proprietary, and thus CAS numbers and other limited information may not be available for release.

In no event shall TI's liability arising out of such information exceed the total purchase price of the TI part(s) at issue in this document sold by TI to Customer on an annual basis.

TAPE AND REEL INFORMATION

QUADRANT ASSIGNMENTS FOR PIN 1 ORIENTATION IN TAPE

*All dimensions are nominal

Device	Package Type	Package Drawing	Pins	SPQ	Reel Diameter (mm)	Reel Width W1 (mm)	A0 (mm)	B0 (mm)	K0 (mm)	P1 (mm)	W (mm)	Pin1 Quadrant
LM3502ITL-16/NOPB	DSBGA	YPA	10	250	178.0	8.4	2.03	2.21	0.76	4.0	8.0	Q1
LM3502ITL-25/NOPB	DSBGA	YPA	10	250	178.0	8.4	2.03	2.21	0.76	4.0	8.0	Q1
LM3502ITL-35/NOPB	DSBGA	YPA	10	250	178.0	8.4	2.03	2.21	0.76	4.0	8.0	Q1
LM3502ITL-44/NOPB	DSBGA	YPA	10	250	178.0	8.4	2.03	2.21	0.76	4.0	8.0	Q1
LM3502ITLX-16/NOPB	DSBGA	YPA	10	3000	178.0	8.4	2.03	2.21	0.76	4.0	8.0	Q1
LM3502ITLX-25/NOPB	DSBGA	YPA	10	3000	178.0	8.4	2.03	2.21	0.76	4.0	8.0	Q1
LM3502ITLX-35/NOPB	DSBGA	YPA	10	3000	178.0	8.4	2.03	2.21	0.76	4.0	8.0	Q1
LM3502ITLX-44/NOPB	DSBGA	YPA	10	3000	178.0	8.4	2.03	2.21	0.76	4.0	8.0	Q1
LM3502SQ-16	WQFN	RGH	16	1000	178.0	12.4	4.3	4.3	1.3	8.0	12.0	Q1
LM3502SQ-16/NOPB	WQFN	RGH	16	1000	178.0	12.4	4.3	4.3	1.3	8.0	12.0	Q1
LM3502SQ-25	WQFN	RGH	16	1000	178.0	12.4	4.3	4.3	1.3	8.0	12.0	Q1
LM3502SQ-25/NOPB	WQFN	RGH	16	1000	178.0	12.4	4.3	4.3	1.3	8.0	12.0	Q1
LM3502SQ-35	WQFN	RGH	16	1000	178.0	12.4	4.3	4.3	1.3	8.0	12.0	Q1
LM3502SQ-35/NOPB	WQFN	RGH	16	1000	178.0	12.4	4.3	4.3	1.3	8.0	12.0	Q1
LM3502SQ-44	WQFN	RGH	16	1000	178.0	12.4	4.3	4.3	1.3	8.0	12.0	Q1
LM3502SQ-44/NOPB	WQFN	RGH	16	1000	178.0	12.4	4.3	4.3	1.3	8.0	12.0	Q1
LM3502SQX-16	WQFN	RGH	16	4500	330.0	12.4	4.3	4.3	1.3	8.0	12.0	Q1
LM3502SQX-16/NOPB	WQFN	RGH	16	4500	330.0	12.4	4.3	4.3	1.3	8.0	12.0	Q1

Device	Package Type	Package Drawing	Pins	SPQ	Reel Diameter (mm)	Reel Width W1 (mm)	A0 (mm)	B0 (mm)	K0 (mm)	P1 (mm)	W (mm)	Pin1 Quadrant
LM3502SQX-25	WQFN	RGH	16	4500	330.0	12.4	4.3	4.3	1.3	8.0	12.0	Q1
LM3502SQX-25/NOPB	WQFN	RGH	16	4500	330.0	12.4	4.3	4.3	1.3	8.0	12.0	Q1
LM3502SQX-35	WQFN	RGH	16	4500	330.0	12.4	4.3	4.3	1.3	8.0	12.0	Q1
LM3502SQX-35/NOPB	WQFN	RGH	16	4500	330.0	12.4	4.3	4.3	1.3	8.0	12.0	Q1
LM3502SQX-44	WQFN	RGH	16	4500	330.0	12.4	4.3	4.3	1.3	8.0	12.0	Q1
LM3502SQX-44/NOPB	WQFN	RGH	16	4500	330.0	12.4	4.3	4.3	1.3	8.0	12.0	Q1

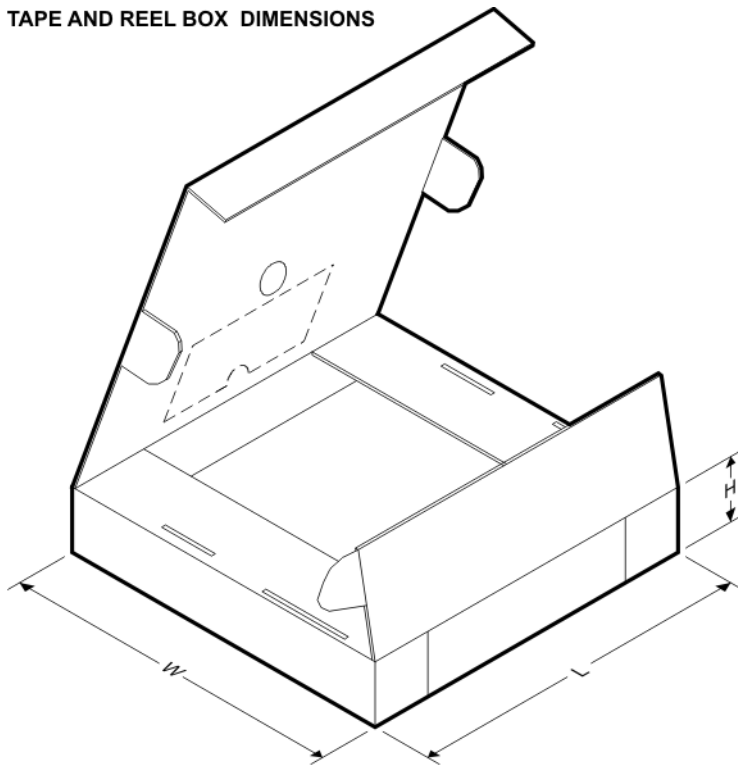
TAPE AND REEL BOX DIMENSIONS

*All dimensions are nominal

Device	Package Type	Package Drawing	Pins	SPQ	Length (mm)	Width (mm)	Height (mm)
LM3502ITL-16/NOPB	DSBGA	YPA	10	250	210.0	185.0	35.0
LM3502ITL-25/NOPB	DSBGA	YPA	10	250	210.0	185.0	35.0
LM3502ITL-35/NOPB	DSBGA	YPA	10	250	210.0	185.0	35.0
LM3502ITL-44/NOPB	DSBGA	YPA	10	250	210.0	185.0	35.0
LM3502ITLX-16/NOPB	DSBGA	YPA	10	3000	210.0	185.0	35.0
LM3502ITLX-25/NOPB	DSBGA	YPA	10	3000	210.0	185.0	35.0
LM3502ITLX-35/NOPB	DSBGA	YPA	10	3000	210.0	185.0	35.0
LM3502ITLX-44/NOPB	DSBGA	YPA	10	3000	210.0	185.0	35.0
LM3502SQ-16	WQFN	RGH	16	1000	203.0	190.0	41.0
LM3502SQ-16/NOPB	WQFN	RGH	16	1000	203.0	190.0	41.0
LM3502SQ-25	WQFN	RGH	16	1000	203.0	190.0	41.0

Device	Package Type	Package Drawing	Pins	SPQ	Length (mm)	Width (mm)	Height (mm)
LM3502SQ-25/NOPB	WQFN	RGH	16	1000	203.0	190.0	41.0
LM3502SQ-35	WQFN	RGH	16	1000	203.0	190.0	41.0
LM3502SQ-35/NOPB	WQFN	RGH	16	1000	203.0	190.0	41.0
LM3502SQ-44	WQFN	RGH	16	1000	203.0	190.0	41.0
LM3502SQ-44/NOPB	WQFN	RGH	16	1000	203.0	190.0	41.0
LM3502SQX-16	WQFN	RGH	16	4500	349.0	337.0	45.0
LM3502SQX-16/NOPB	WQFN	RGH	16	4500	349.0	337.0	45.0
LM3502SQX-25	WQFN	RGH	16	4500	349.0	337.0	45.0
LM3502SQX-25/NOPB	WQFN	RGH	16	4500	349.0	337.0	45.0
LM3502SQX-35	WQFN	RGH	16	4500	349.0	337.0	45.0
LM3502SQX-35/NOPB	WQFN	RGH	16	4500	349.0	337.0	45.0
LM3502SQX-44	WQFN	RGH	16	4500	349.0	337.0	45.0
LM3502SQX-44/NOPB	WQFN	RGH	16	4500	349.0	337.0	45.0

RGH0016A

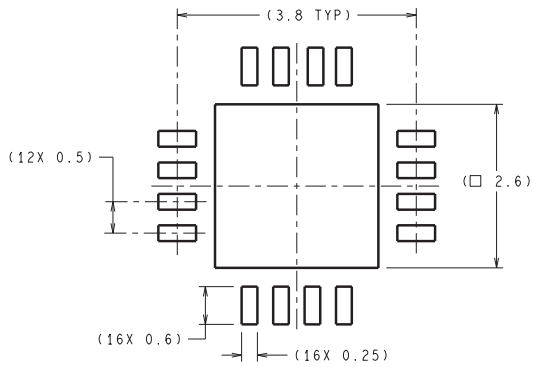

RECOMMENDED LAND PATTERN

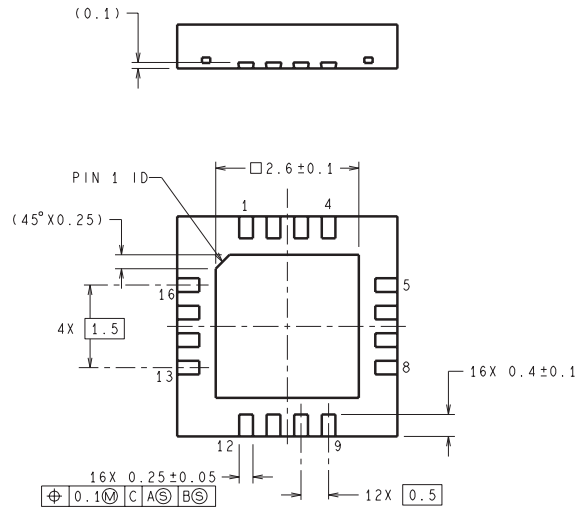
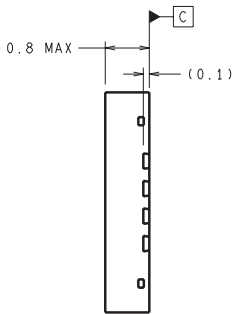
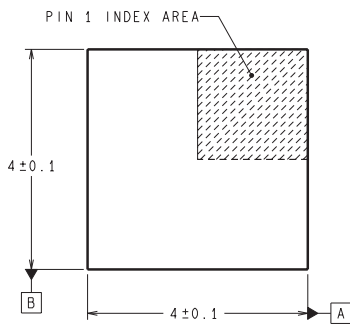

DIMENSIONS ARE IN MILLIMETERS
DIMENSIONS IN () FOR REFERENCE ONLY

SQA16A (Rev A)

YPA0010

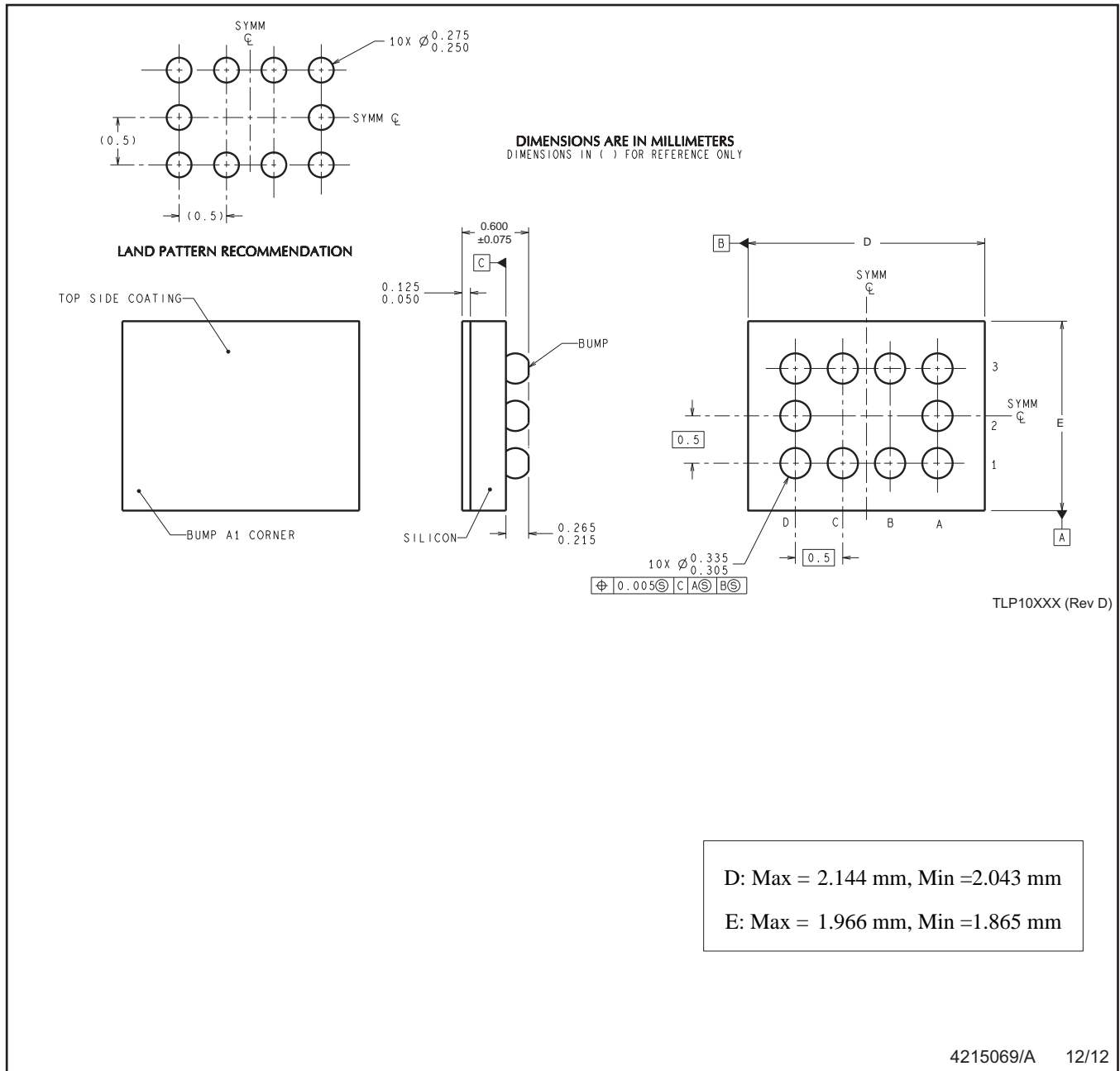

NOTES: A. All linear dimensions are in millimeters. Dimensioning and tolerancing per ASME Y14.5M-1994.
B. This drawing is subject to change without notice.

IMPORTANT NOTICE

Texas Instruments Incorporated and its subsidiaries (TI) reserve the right to make corrections, enhancements, improvements and other changes to its semiconductor products and services per JESD46, latest issue, and to discontinue any product or service per JESD48, latest issue. Buyers should obtain the latest relevant information before placing orders and should verify that such information is current and complete. All semiconductor products (also referred to herein as "components") are sold subject to TI's terms and conditions of sale supplied at the time of order acknowledgment.

TI warrants performance of its components to the specifications applicable at the time of sale, in accordance with the warranty in TI's terms and conditions of sale of semiconductor products. Testing and other quality control techniques are used to the extent TI deems necessary to support this warranty. Except where mandated by applicable law, testing of all parameters of each component is not necessarily performed.

TI assumes no liability for applications assistance or the design of Buyers' products. Buyers are responsible for their products and applications using TI components. To minimize the risks associated with Buyers' products and applications, Buyers should provide adequate design and operating safeguards.

TI does not warrant or represent that any license, either express or implied, is granted under any patent right, copyright, mask work right, or other intellectual property right relating to any combination, machine, or process in which TI components or services are used. Information published by TI regarding third-party products or services does not constitute a license to use such products or services or a warranty or endorsement thereof. Use of such information may require a license from a third party under the patents or other intellectual property of the third party, or a license from TI under the patents or other intellectual property of TI.

Reproduction of significant portions of TI information in TI data books or data sheets is permissible only if reproduction is without alteration and is accompanied by all associated warranties, conditions, limitations, and notices. TI is not responsible or liable for such altered documentation. Information of third parties may be subject to additional restrictions.

Resale of TI components or services with statements different from or beyond the parameters stated by TI for that component or service voids all express and any implied warranties for the associated TI component or service and is an unfair and deceptive business practice. TI is not responsible or liable for any such statements.

Buyer acknowledges and agrees that it is solely responsible for compliance with all legal, regulatory and safety-related requirements concerning its products, and any use of TI components in its applications, notwithstanding any applications-related information or support that may be provided by TI. Buyer represents and agrees that it has all the necessary expertise to create and implement safeguards which anticipate dangerous consequences of failures, monitor failures and their consequences, lessen the likelihood of failures that might cause harm and take appropriate remedial actions. Buyer will fully indemnify TI and its representatives against any damages arising out of the use of any TI components in safety-critical applications.

In some cases, TI components may be promoted specifically to facilitate safety-related applications. With such components, TI's goal is to help enable customers to design and create their own end-product solutions that meet applicable functional safety standards and requirements. Nonetheless, such components are subject to these terms.

No TI components are authorized for use in FDA Class III (or similar life-critical medical equipment) unless authorized officers of the parties have executed a special agreement specifically governing such use.

Only those TI components which TI has specifically designated as military grade or "enhanced plastic" are designed and intended for use in military/aerospace applications or environments. Buyer acknowledges and agrees that any military or aerospace use of TI components which have **not** been so designated is solely at the Buyer's risk, and that Buyer is solely responsible for compliance with all legal and regulatory requirements in connection with such use.

TI has specifically designated certain components as meeting ISO/TS16949 requirements, mainly for automotive use. In any case of use of non-designated products, TI will not be responsible for any failure to meet ISO/TS16949.

Products

Audio	www.ti.com/audio
Amplifiers	amplifier.ti.com
Data Converters	dataconverter.ti.com
DLP® Products	www.dlp.com
DSP	dsp.ti.com
Clocks and Timers	www.ti.com/clocks
Interface	interface.ti.com
Logic	logic.ti.com
Power Mgmt	power.ti.com
Microcontrollers	microcontroller.ti.com
RFID	www.ti-rfid.com
OMAP Applications Processors	www.ti.com/omap
Wireless Connectivity	www.ti.com/wirelessconnectivity

Applications

Automotive and Transportation	www.ti.com/automotive
Communications and Telecom	www.ti.com/communications
Computers and Peripherals	www.ti.com/computers
Consumer Electronics	www.ti.com/consumer-apps
Energy and Lighting	www.ti.com/energy
Industrial	www.ti.com/industrial
Medical	www.ti.com/medical
Security	www.ti.com/security
Space, Avionics and Defense	www.ti.com/space-avionics-defense
Video and Imaging	www.ti.com/video

TI E2E Community

e2e.ti.com

Mouser Electronics

Authorized Distributor

Click to View Pricing, Inventory, Delivery & Lifecycle Information:

Texas Instruments:

[LM3502ITL-44EV](#) [LM3502SQ-16](#) [LM3502SQ-25](#) [LM3502SQ-35](#) [LM3502SQ-44](#) [LM3502SQX-16](#) [LM3502SQX-25](#)
[LM3502SQX-35](#) [LM3502SQX-44](#)